



油霧回收機 GEP 系列使用說明書

GREEN ECO PRO CNC OIL MIST COLLECTORS

INSTRUCTION MANUAL



瑞亞精密股份有限公司 TEL: +8864 25359633

www.greenecopro.com.tw

42755 台中市崇德路四段 183 巷 12-19 號



Dimension & Carton 機械尺寸

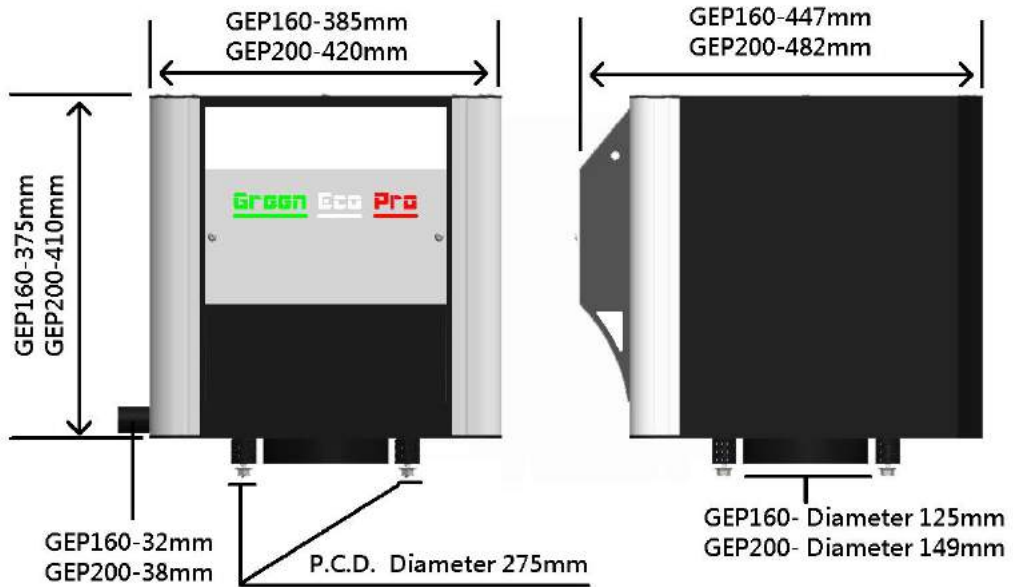

Description of each part 各部解說

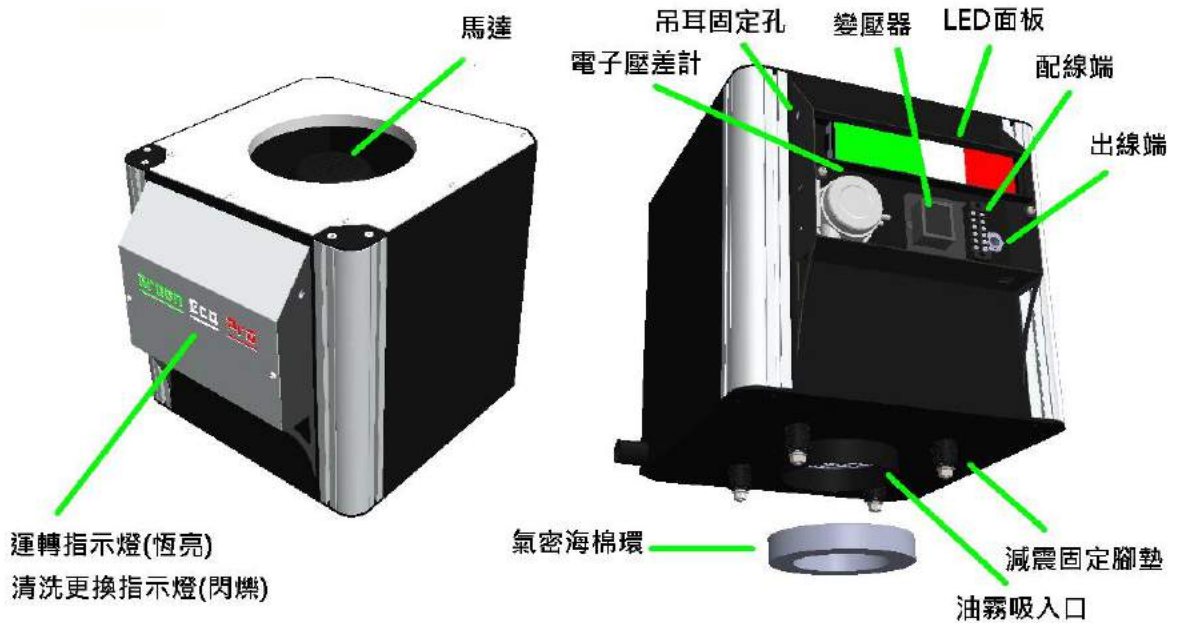



安裝型式1 直接安裝

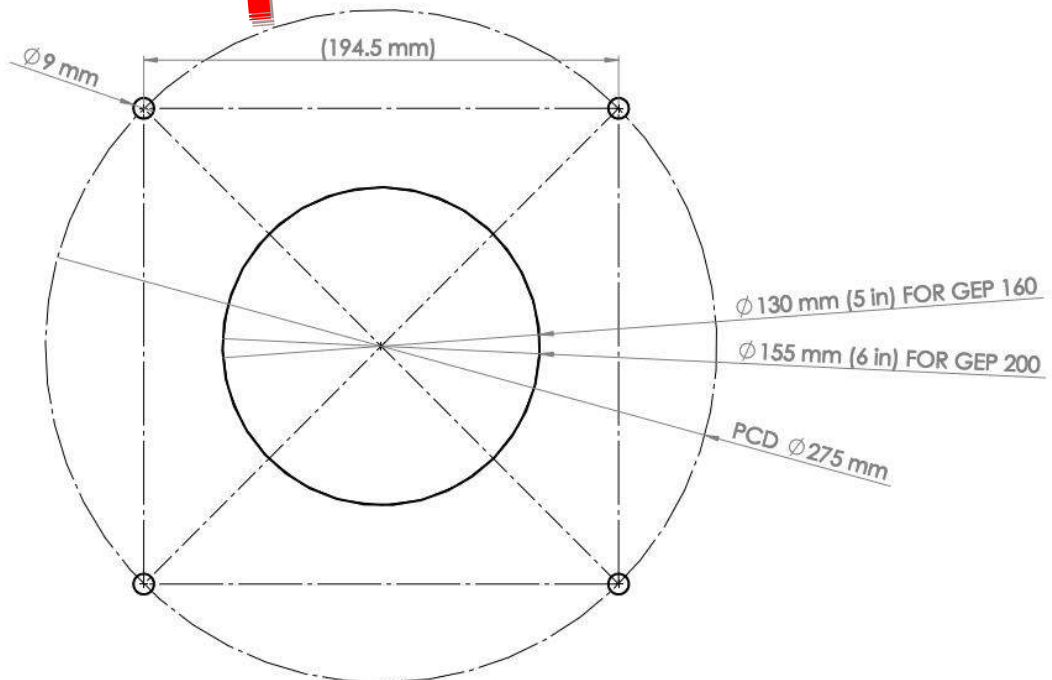

直接安裝時 設備開孔尺寸



安裝型式 2 立柱安裝

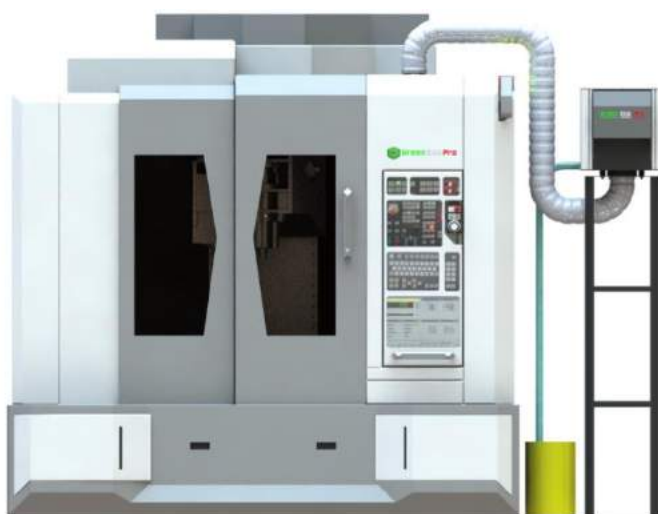

立柱安裝相關零組件皆為選配



配線圖

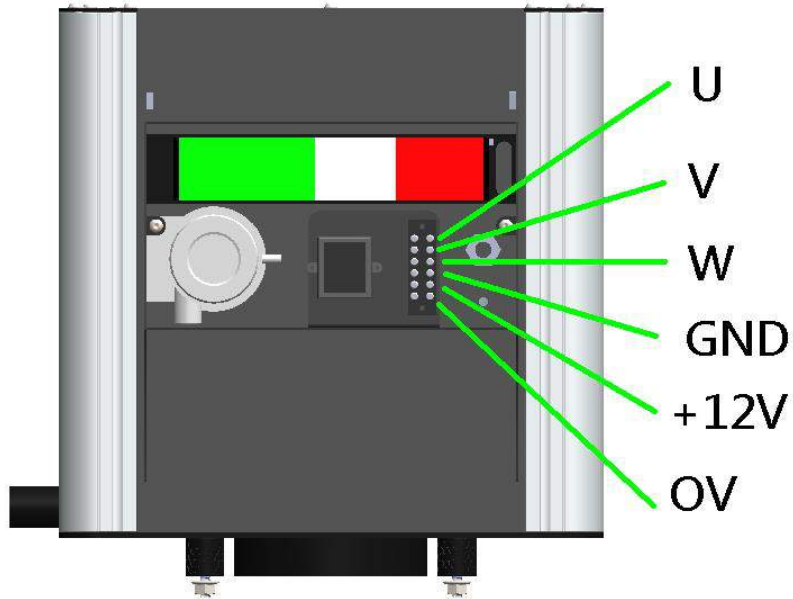

規格

| Model | GEP-160 | GEP-200 | Unit |
|-----------------------|-----------|-----------|--------------------|
| Power | 380/220 | | V |
| Moter Power | 0.37 | | kw |
| Frequency | 50/60 | | Hz |
| Inhalation caliber | 125 / 149 | | mm |
| Filter rate | 99.9 | | % |
| Vibration rate | G 2.5 | | mm/s |
| Air volume | 16 | 20 | M ³ min |
| Noises volume | 65 | 69 | dB |
| Most static pressures | 1280 | 1430 | Pa |
| Machines fully cover | 1.25Under | 1.6 Under | M |



配備

| Model | GEP-160 | GEP-200 | Unit |
|---------------------------------|----------------------------------|----------------------------------|-----------------------------|
| Multiple filter | RE-CLEAN USING | | |
| Operation Indication | <input checked="" type="radio"/> | <input checked="" type="radio"/> | Light |
| Clean an indicator Light | <input checked="" type="radio"/> | <input checked="" type="radio"/> | Glisten |
| Filter smoking tube (Option) | <input type="radio"/> | <input type="radio"/> | Longer-acting type/600mm |
| Column (Option) | <input type="radio"/> | <input type="radio"/> | |



High efficiency Filter smoking tube (option)



日常保養

1

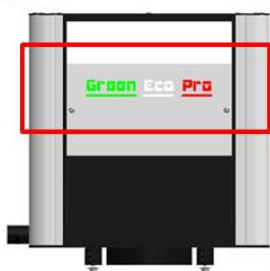

閃
爍
警
示

2



3

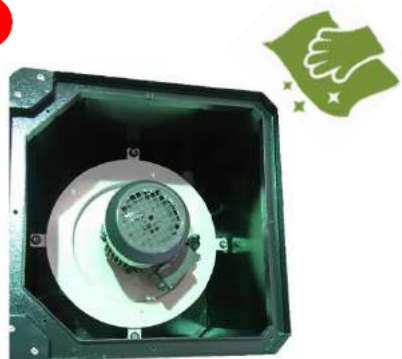

4



更
換
新
濾
煙
筒

1. 當運轉指示燈開始閃爍時，表示須清洗或更換裝置。
2. 請先將黑色海綿取出使用清潔劑或白博士清潔劑清洗，並用高壓風槍完全風乾；鐵網也須使用清潔劑或白博士清潔劑清洗，並噴乾。
3. 將風扇、葉輪及馬達用高壓風槍將灰塵清潔或抹布擦拭表面。
4. 將已飽和的濾煙筒做更換。

保固書

WARRANTY STATEMENT

| | |
|---------------------------------|---|
| Model 機型 | <i>GREEN ECO PRO CNC Coolant Filter Cycle Systems</i> 油霧回收機 GEP-160 200 |
| Manufacture date 出廠日期 | |
| Serial number 機台編號 | |

服務保固範圍:

經由瑞亞精密股份有限公司或特許經銷商購置之新機械.於正常使用情況內,且於品質保證期內,如發現原裝之零件或裝配有瑕疵導致故障,經由總公司認定,將予以免費提供零件與維修。

品質保證期限:

自交機日起,提供非人為損壞之免費零件為期一年之保固。

保固除外責任規定:

- 1.未依照本公司提供之內容施行定檢保養.所造成機械損害或故障。
- 2.不正常操作與環境下.外力衝擊等.造成機械損害或故障。
- 3.保固範圍不包括意外事件如:火災、風災、水災、地震等不可抗力之災害。
- 4.本機相關配件如濾心、於不正常使用下損壞或遺失。
- 5.保固期內自行拆解機械,自行改裝,造成機械損害或故障。
- 6.保固書未加蓋本司或特許之經銷商店章或是經過塗改,則該保固書視同無效。